



**OWNERS GUIDE**

# **Hydraulic Residential Elevator**

**Series: F114, F116  
FVE HPU**

1726 North Ballard Road, Suite 1 • Appleton, WI 54911  
Phone 920-991-9082 • Fax 920-991-9087  
Technical Support 855-804-5774



# Congratulations!

---

On your choice of a Fox Valley Elevator, LLC Residential Elevator.

Your elevator is manufactured in accordance with the ASME A17.1/ CSA B44 Safety Code for Elevators and Escalators.

Your new elevator will give you many years of excellent service with proper maintenance and use. However, you must always follow all safety procedures.

This Owner's Guide should be reviewed periodically and saved for future reference.

## Members Of:

---

Fox Valley Elevator, LLC is a proud member of The American Society of Mechanical Engineers, The National Association Elevator Contractors, The Canadian Elevator Contractor Association, The Accessibility Equipment Manufacturers Association. These symbols assure you of our commitment to high quality and accessibility to everyone.



## Table of Contents

---

Introduction.....	4
Serial Number .....	4
Maintenance and Service .....	4
Important Operating Note.....	5
Safety Features & Assumption of Risk.....	6
Basic Elevator Operating Instructions.....	7
Descriptive Features.....	8-10
Basic Troubleshooting.....	11
Emergency Procedures.....	12-15
Description of Programs.....	16-21
Is my Elevator Safe, True or False Form.....	22
Your Elevator 101.....	23
Manufactures Limited Warranty.....	24-25
Notes.....	26

Note: The equipment described within this guide may not be identified as either standard or optional and the various illustrations may not all be applicable to your particular unit. Always check with your authorized dealer if you have questions.

\*Fox Valley Elevator, LLC will be referred as Fox Valley Elevator or FVE through out the remainder of this document.

# Introduction

---

Your dealer will instruct you on the proper and safe operation of your Fox Valley Elevator Hydraulic Elevator equipment. **IT IS IMPORTANT THAT YOU READ THIS *OWNER'S GUIDE* CAREFULLY BEFORE USING YOUR NEW ELEVATOR.**

Your elevator was designed for years of dependable service. However, as with all electrical and mechanical equipment, proper operation and periodic maintenance is absolutely required. Maintenance instructions are available and are to be used by qualified personnel only. For optimal performance, Fox Valley Elevator recommends that you establish a periodic maintenance agreement with your authorized dealer. Do not try to service or repair the elevator yourself.

## Elevator Serial Number

---



This serial number contains specific information about your elevator, allowing technicians to properly identify replacement parts.

## Maintenance and Service

---

### Elevator Dealer Information

Company: \_\_\_\_\_

Address: \_\_\_\_\_

\_\_\_\_\_

\_\_\_\_\_

Contact: \_\_\_\_\_



















Phone Number: \_\_\_\_\_

# Important Operating Notes

---



Designates a condition where failure to follow instructions or heed warning could result in serious personal injury or death. When you see this symbol **HEED IT'S MESSAGE**.

-  Anyone using this elevator must be trained on its proper use and have read this owner's guide.
-  Always verify the elevator has properly leveled at the landing (to avoid tripping or falling) before entering or exiting the car.
-  Do not lean against the elevator gate or the control panel.
-  Do not allow unsupervised children to use this elevator.
-  Do not attempt to bypass or otherwise tamper with any of the safety systems.
-  Do not exceed the maximum capacity of the elevator. A capacity tag is posted in the car.
-  Never open a gate or the hoistway door while the elevator is in motion (it will stop the elevator).
-  The car gate(s) must always be kept in the closed position except during entry and exit of the elevator car. Your elevator will only operate if the gate(s) is securely closed.
-  If you open the hoistway door and do not open the car gate, the elevator will not respond to calls.
-  Do not use your elevator to transport freight.
-  If you detect a problem with your elevator, do not use it. Call your elevator dealer immediately.
-  Do not use this elevator in the event of a fire, smoke, flooding, or earthquake.
-  FVE suggests that you avoid using your elevator during severe weather conditions when there is a strong possibility of power surges or outages.
-  Do not use if there is a possibility of weather related damage to the elevator equipment or hoistway (i.e., flooding, shifted, or tilting hoistway walls).
-  Do not use your elevator if the gate switches or hoistway door locks are not operating properly. Call your dealer or service person at once.
-  Never extend parts of the body or any objects through the gate(s) while operating.
-  Safe operation requires a maintained hoistway temperature between 60° - 110°F with relative humidity not exceeding 95%..  
**Note:** The frequency drive may be heard running for thermal heat dissipation at any time.
-  Do not expose electrical components to the elements or extreme temperature fluctuations. Resulting condensation will damage equipment, causing it to malfunction. If exposed, let it sit for 12-24 hours prior to operation.

# Safety Features

---

Your FVE is equipped with many safety features you should be aware of.

- **Broken Rope Safety.** Mechanically stops the elevator if one or both of the cable(s) break or slacks.
- **Car Gate Safety Switch.** The elevator will not operate if a gate is open.
- **Final Limit Switch.** Stops the elevator if unit travels beyond normal operating limits.
- **Hoistway Door Interlocks.** Renders the elevator inoperable while a hoistway door is open and locks the door when the elevator is not at the floor.
- **Low Pressure Switch.** The elevator will not operate if the pressure in the hydraulic system drops too low.
- **Pipe Rupture Valve.** The elevator will not operate if the hydraulic oil in the cylinder flows out at too fast of a rate.
- **Pressure Relief Valve.** Bypasses hydraulic fluid to the tank reservoir if the hydraulic system becomes overloaded.
- **Safety Run Timer.** If the unit becomes overloaded, the pump will only run for 90 seconds before timing out.
- **Slack Cable Safety Switch.** Electrically prevents the elevator from traveling if the cables become slack or break.
- **Buffer Spring.** If present, are device with one or more springs to cushion the impact force of a descending elevator.
- **Door Fault.** If present, the elevator controller will monitor the door closed and the door locked circuit of the hoistway door interlocks on all floor landings. If the elevator detects the door closed circuit open when the elevator is not within the landing zone, it will disable the power to the driving machine. When this happens, the elevator will not operate in automatic mode and will need to be reset.

**DO NOT TAMPER WITH ANY SAFETY FEATURE!**

## Assumption of Risk

---

ALL PERSONS who use this elevator bear the responsibility for proper use of this product.

Misuse, deliberate or otherwise, voids all warranties... written or expressed!

Fox Valley Elevator is **NOT** responsible for any injury or death resulting from product modification, additions or other changes which take place after the product has left the manufacturer's plant.

# Basic Elevator Operating Instructions

---

- 1. Press the Call Button** - This will call the elevator to your floor and allow you to open the hoistway door.
- 2. Open the Hoistway Door** - Open the door or the auto door will open once the elevator has come to a complete stop at your floor.
- 3. Check for Leveling** - Visually verify that the elevator has leveled properly, to avoid tripping or falling.
- 4. Open the Gate.**  
*Automatic Gate Operation:* The gate will automatically open.  
*Manual Gate Operation:* Slide the gate open. Always use the gate handle.
- 5. Enter the Elevator.**
- 6. Close the Hoistway Door** - Manually close the door, or the auto door will close after you. The elevator will not operate unless the hoistway door is completely closed.
- 7. Close the Gate.**  
*Automatic Gate Operation:* The gate operator will automatically close the gate once the hoistway door is closed.  
*Manual Gate Operation:* Slide the gate closed. Always use the gate handle.
- 8. Press the Desired Floor Button.**
- 9. Complete Travel** - Wait for the elevator to complete its travel to the desired floor and come to a complete stop.
- 10. Open the Gate.**  
*Automatic Gate Operation:* The gate will automatically open.  
*Manual Gate Operation:* Slide the gate open. Always use the gate handle.
- 11. Check for Leveling** - Visually verify that the elevator has leveled properly before stepping out of the elevator to avoid tripping or falling.
- 12. Open the Hoistway Door** - Open the door or the auto door will open once the elevator has come to a complete stop at your floor.
- 13. Exit the Elevator**
- 14. Close Gate**  
*Automatic Gate Operation:* The gate operator will automatically close the gate once the hoistway door is closed.  
*Manual Gate Operation:* Firmly close the gate before the hoistway door as you exit the elevator.
- 15. Close the Hoistway Door** - Manually close the door securely, or the auto door will close for you as you exit the elevator.

**Note:** The elevator will not respond to another call if the gate to the hoistway door is not completely closed.

If you open the hoistway door and do not open the gate the elevator will not respond to calls.

**Note:** The descriptions and specifications contained in this guide were in effect at the time the guide was approved for printing. Fox Valley Elevator reserves the right to discontinue models without notice and without incurring obligation. The equipment described within this guide may not be identified as either standard or optional and the various illustrations may not all be applicable to your particular unit. If you have questions, always check with your Elevator Dealer.

# Descriptive Features

---

It is important that you familiarize yourself with the features of your new FVE before using.

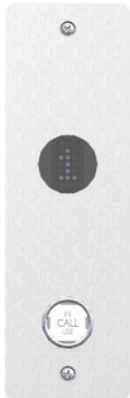

## Hall Station

Hall Station should be located near the hoistway door.

- **Car Call Button** - Press this button to call the car to your floor. The button will illuminate while the elevator is in motion or to unlock the hoistway door if the elevator is already at the floor.
- **Car Here Light** - If present, this light will illuminate when the elevator has reached the floor.
- **Key Lock** - Some hall stations may be equipped with an optional key lock. The key must be turned on for the button to become active.
- **Position Indicator** - If present, it lets you see what floor the elevator is on.
- **Door Fault Light** - If present, this light will illuminate when the door closed circuit is opened with the elevator car, not in the landing zone of any floor.
- **Maintenance** - Clean your hall station plate with a clean cloth. Do not use harsh chemicals or abrasive cleaners, which may damage the clear coat.



---

## Car Operating Panel

Car Operating Panel will be located inside of the elevator car.



- **Floor Buttons** - Press a floor button to send the car to a floor. The button will illuminate when depressed.
- **Alarm Button** - When pressed, the alarm bell rings, alerting others within the home to your need for assistance.
- **Emergency Stop Knob** - Immediately stops the elevator when pushed.
- **Light Switch** - A light switch for your convenience comes standard on all car operating panels.
- **Key Locks** - Optional key locks may be added for controlled access and safety.
- **Position indicator** - If present, lets you know your location as you travel by each floor.
- **Emergency Light** - If present, illuminates if the power goes out.
- **Maintenance** - Clean your car operating panel faceplate with a clean cloth.

Do not use harsh chemicals or abrasive cleaners, which may damage the clear coat.



# Descriptive Features Continued...

---



## Telephone Jack

- **Telephone Jack.** Fox Valley Elevator, Elevators are equipped with a telephone jack. Some elevators are equipped with an optional flush-mount telephone box (shown here) or a flush-mount telephone keypad or integrated into the car operating panel
-  A phone must be plugged into the phone jack at all times, and the phone line must be operational!
- **Maintenance.** Periodically check to make certain the telephone is in good working order.

GAL Interlock Key



## Hoistway Door Interlock

The interlock is located inside the hoistway at the top corner or in the door jamb on the latch side of the door. This locks the hoistway door when the car is not at a landing.

EMI Interlock Key



- **Emergency Key.** Can be used to open the door from outside the hoistway in case of emergency or for servicing.  
**This key is to be used only for emergencies.**
  - **GAL Interlock.** Insert the emergency release key into the hole (near the top of the door) and turn (toward the center of the door) to release the interlock while opening the door.
  - **EMI Interlock.** Insert the emergency release key into the hole (near the top of the door) and pull the center downward to release the interlock while opening the door.
  - **Prudhomme Interlock.** Insert the emergency release key into the hole (in the door trim) and turn to release the Prudhomme interlock while opening the door.
- Note:** Key will only turn one way depending on the hand of the interlock.

Prudhomme Interlock Key



Accordion Gate

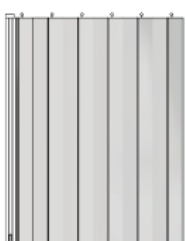

## Accordion Gate

The Accordion Gate the car opening during operation. This gate provides a barrier between the car and the hoistway.

-  DO NOT lean on, push on, pull on or open the gate while the elevator is in motion. It can stop the elevator.
- **Maintenance.** Dust and clean the surfaces of your gate with a clean cloth. Do not use harsh chemicals or abrasive cleaners. Keep the gate tracks clear of dirt or debris.

# Descriptive Features Continued...

---

## Automatic Gate Operator



Automatically opens and closes the accordion car gate of the elevator. This option is only available with accordion gates.

- **Convenience.** One less step to remember during the operation of your new elevator.
- **Hands-Free.** Very helpful for those with limited mobility and strength.
- **Out of Sight.** The automatic gate operator is mounted on the top of the elevator car.

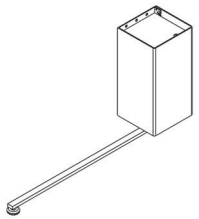

## Automatic Door Operator

Automatically opens and closes the Hoistway Door of the elevator.

- **Convenience.** One less step to remember during the operation of your new elevator.
- **Hands-Free.** Very helpful for those with limited mobility and strength.
- **Versatile .** It can be used with interior or exterior doors.

# Basic Troubleshooting

---

## **Before Calling for Service...**

Verify that the elevator has power.

If you open the hoistway door and do not open the gate, the elevator will not respond to calls.

Check the red emergency knob on the car operating panel by pushing and then pulling the knob back into the proper running position.

Verify that all gates and hoistway doors are securely closed by opening and closing the doors and gates. The elevator will not operate if a gate or door is partially open.

Pushing call buttons or floor buttons repeatedly will delay operation and potentially shut down controls. Wait 7 seconds between calls.

Do not attempt to repair the elevator yourself.

**If your elevator still will not function call your authorized elevator dealer immediately.**

# Emergency Procedures

## Emergency Battery Lowering of Car

In the case of a power failure, the battery backup allows the elevator's occupant(s) to travel to any chosen floor below the elevator's current position. Select the desired floor by pushing the appropriate floor button after 7 seconds.

Follow your standard elevator exiting procedures.

Call your dealer for service if the elevator has not reset itself after power is restored or if the battery backup systems did not work.

## Emergency Manual Lowering of Elevator Car

**SEVERE INJURY COULD RESULT IF THE ELEVATOR SHOULD START UP OR ENERGIZE IN THE MIDDLE OF AN EMERGENCY EXTRACTION.**

- ⚠ Push the Alarm Button to alert others in home that your in need of help.**
- ⚠ Stay calm and call for help on the telephone.**
- ⚠ This procedure must only be used during an emergency. If the elevator is experiencing stalling call for service immediately.**
- ⚠ Push the emergency stop knob before starting the manually lowering procedures.**
- ⚠ The service disconnects (located in the control space) must be in the "OFF" position, and the breaker(s) for all elevator circuits must be "OFF" in the main breaker box.**

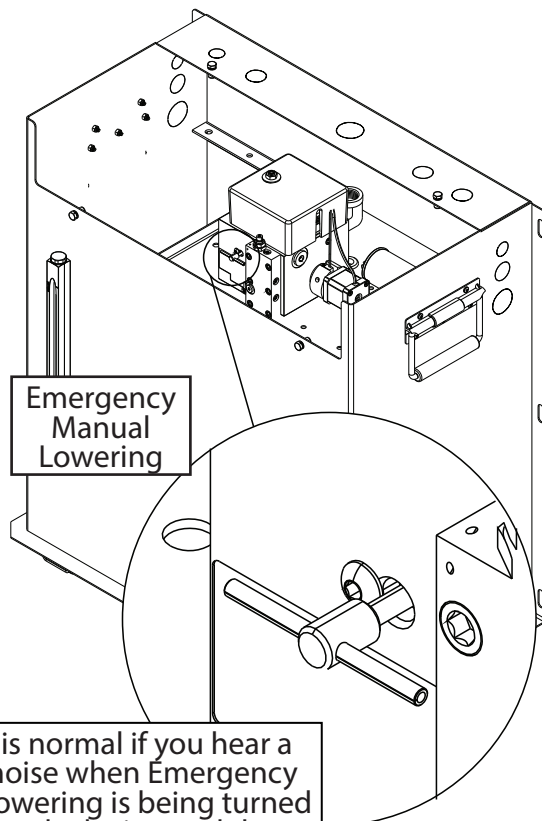

**Note:** It is normal if you hear a hissing noise when Emergency Manual Lowering is being turned counter-clockwise and the elevator car is moving.

If you are unable to send the elevator to a lower floor, you can manually lower the car by using the Emergency Manual Lowering:

1. Verify that the service disconnect is in the "OFF" position.
2. Push the Emergency Stop button on the Car Operating Panel inside the elevator car.
3. On the hydraulic valve there is a t-handle Emergency Manual Lowering valve.
4. Slowly turn the t-handle counter-clockwise until the car moves at a controlled rate.
5. Turn the t-handle clockwise to stop the elevator car from lowering at the nearest floor below the stalled location.
6. Manually open the gate and hoistway door to exit the elevator car.
7. Call for immediate service of the elevator before continuing to operate the unit.

**Note:** Car occupant(s) and rescuer(s) will need to work together.

# Emergency Procedures Continued...

---

## Emergency Opening of the Hoistway Door from Outside the Elevator

The procedure for releasing the interlock will depend on which type of interlock is used with the elevator. All interlocks are designed to be opened from outside of the hoistway door. To open the hoistway door FVE recommends the following procedure:

- ⚠ If you open the hoistway door and do not open the gate, the elevator will not respond to calls.
- 

### Prudhomme Interlock

If your elevator is equipped with a Prudhomme Interlock, use the Emergency key provided to open the lock from outside of the hoistway. Insert the emergency key into the hole (in the door frame), interlocking the triangle shapes, and turn the key to release the interlock while opening the door.

- Call your dealer for service before using the elevator again.

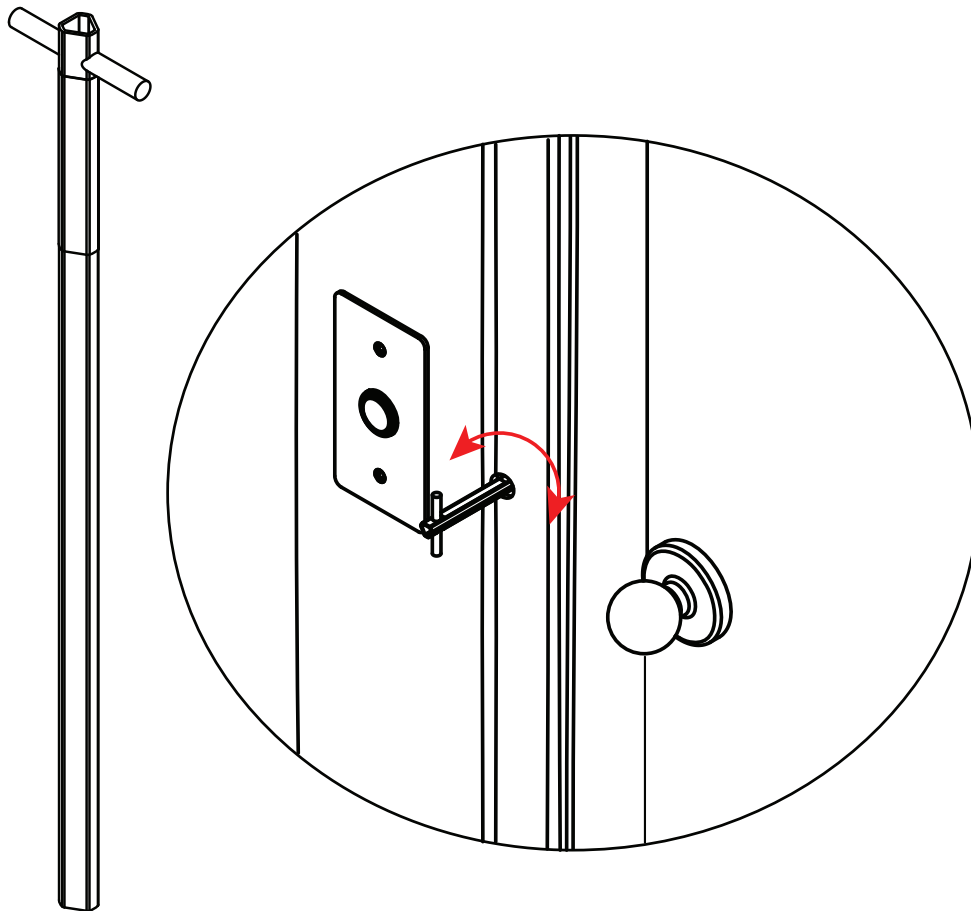

# Emergency Procedures Continued...

## Emergency Opening of the Hoistway Door from Outside the Elevator

The procedure for releasing the interlock will depend on which type of interlock is used with the elevator. All interlocks are designed to be opened from outside of the hoistway door. To open the hoistway door FVE recommends the following procedure:

- ⚠ If you open the hoistway door and do not open the gate, the elevator will not respond to calls.

### EMI Interlock

If your elevator is equipped with an Electromechanical Interlock (EMI) use the key provided to open the lock from the outside of the hoistway. To open the hoistway door, insert half the length of the key through the hole in the hoistway door. **GENTLY** pry the outboard end of the key to lift the interlock pin. Slowly open the hoistway door with the interlock pin raised.

If unable to perform this procedure, proceed to the instructions for unlocking the door from within the elevator.

- Call your dealer for service before using the elevator again.

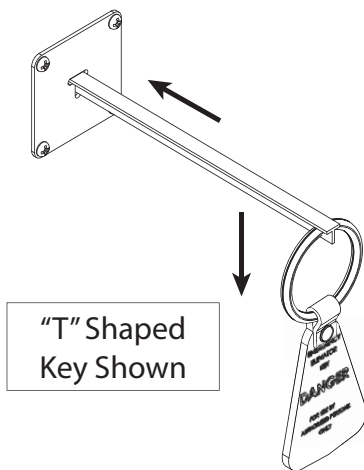

### GAL Interlock

If your elevator is equipped with a GAL "N" Type Interlock, use the key provided to open the lock from the outside of the hoistway. Insert the emergency release key with the tooth side at the top into the hole (near the top of the door) and turn (toward the hinge of the door) to release the interlock while opening the door.

- Call your dealer for service before using the elevator again.

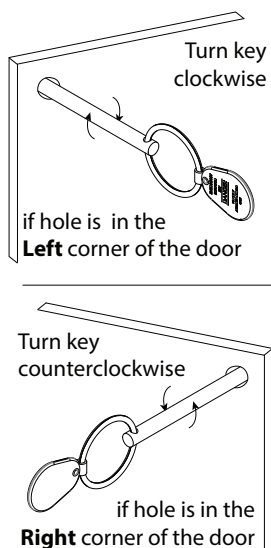

# Emergency Procedures Continued...

## Emergency Opening of the Hoistway Door from Within the Elevator

- ⚠ Use the phone to call for help before attempting to open the hoistway door from within the elevator.
- ⚠ Push the Alarm Button to alert others.
- ⚠ Be sure to push the Emergency Stop Knob. Severe injury could result if the elevator should start up in the middle of an emergency extraction.
- ⚠ If you open the hoistway door and do not open the gate the elevator will not respond to calls.

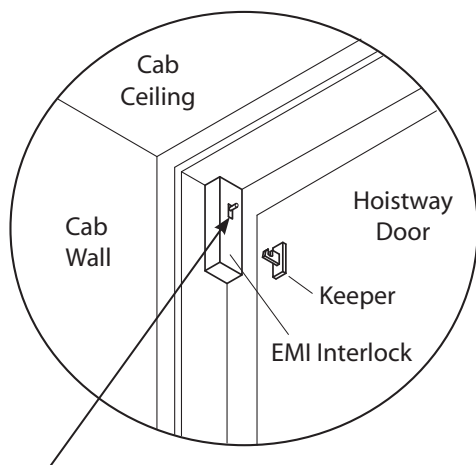

Push the Release Pin Upward

### EMI Interlock

- ⚠ Verify the emergency stop knob is in the push in position.

To open the hoistway door from within the car:

- Open the car gate (Resistance may be encountered)
- Lift the release pin and open the hoistway door while the pin is lifted.

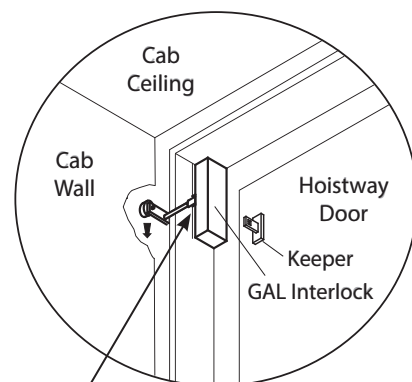

Press the Roller Arm Downward

### GAL Interlock

- ⚠ Verify that the emergency stop knob is in the pushed in position.

To open the hoistway door from within the car:

- Open the car gate (Resistance may be encountered)
- **CAREFULLY** reach into the hoistway, and press down on the roller arm
- Open the hoistway door while holding down on the roller arm.

# Description of Elevator Programs

---

## **Automatic Elevator Program**

Automatic elevator operation is a program which operates the elevator automatically. This allows use without operating electric switches, and is an built in program.

### **How does the Automatic Elevator Program work?**

When the Automatic Elevator Program is turned "ON," the elevator will stop automatically at every floor, allowing people to step in and out without having to press any buttons. The elevator will circulate to every floor, with a 5-minute interval between floors, in a continuous loop until the program is turned "OFF" automatically after 30 hours. When the elevator reaches a floor, the door and the gate will open. The door and gate will stay open for an adjustable time of 10 - 120 seconds. While the timer is running, you may enter or leave the elevator car. After the timer expires, the door will automatically close, followed by the gate. The door or gate must not be obstructed at this time. The elevator will continue the remaining 5-minute floor interval and will cycle the door and gate one last time before sending off to the next floor. The elevator will continue to run automatically in a continuous program loop.

### **How does the Automatic Elevator Program affect the elevator when running in Homing Mode?**

When the Automatic Elevator Program is activated, the Homing Mode will be ignored until the Automatic Elevator Program is deactivated.

### **How will manual floor calls effect the Automatic Elevator Program?**

Manual floor calls can be placed when the Automatic Elevator Program is activated. The elevator will interrupt the program and travel to the desired destination(s). The elevator will then return to the last floor before the interruption, without cycling the door and gate, and continue the same program loop.

### **What happens if the automatic gate closing is interrupted?**

When the automatic gate operator closes the gate and the gate closing is stopped/obstructed or the break-away is tripped, the elevator program will continue to run, but the elevator will not move until the program reaches that floor again internally. The break-away will reconnect itself and continue on with the Automatic Elevator Program.

### **How does my elevator light work?**

When the Automatic Elevator Program is activated, the car light will always remain "ON" as long as the light switch on the car operating panel is "ON."

### **How may I adjust the time period my door stays open?**

Please contact your local dealer if you require your interlock timer to be adjusted.



# Description of Elevator Programs Continued...

## Turn the Automatic Elevator Program "ON".

1. Ride the elevator to the top floor that you want the elevator to circulate to in the program loop.

*For Example:*

*If you have a 3 stop elevator you can set the Automatic Elevator Program to circulate the loop between the 1st and 2nd floors, or you can choose to circulate the loop between all three floors.*

*Please reference the following diagram to see the order sequence of the circulation loop* →

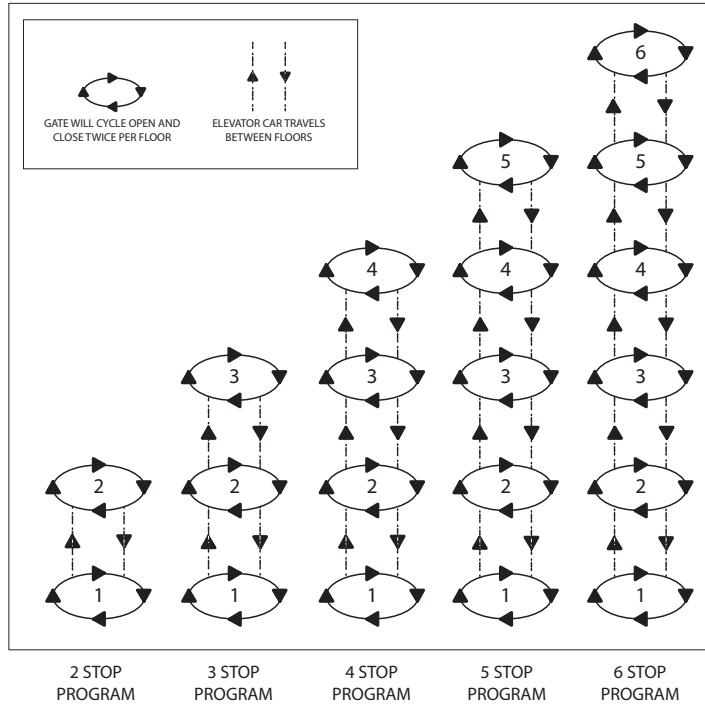

2. Once you arrive at your desired floor, push in the emergency stop knob. Press and hold that floor button for 6 seconds while inside the elevator car. The elevator car lights will turn "OFF" for 2 seconds and back "ON" to acknowledge that the Automatic Elevator Program has been activated.
3. Reset the Emergency Stop Knob by pulling it firmly.

**Note:** The elevator will now run automatically from floor to floor because the Automatic Elevator Program is fully activated. You may place calls as desired instead of waiting for the elevator.

## Turn the Automatic Elevator Program "OFF".

1. To turn the Automatic Elevator Program "OFF," place a call from within the elevator car to the lowest floor and push in the emergency stop knob.
2. Press and hold the lowest floor button for 6 seconds while inside the elevator car. The elevator car lights will turn "OFF" for 2 seconds and back "ON" to acknowledge that the Automatic Elevator Program has been deactivated. The elevator will not run automatically until the Automatic Elevator Program is reactivated.
3. Reset the Emergency Stop Knob by pulling it firmly. The flooring homing program is now turned "Off"

# Description of Elevator Programs Continued...

## Automatic Homing Feature

After a time of 30 minutes with no floor calls, this feature allows the elevator to home to a floor of your choice. All gates and doors are required to be in the fully closed position for the timer to begin counting. The automatic homing feature will not work if you open the hoistway door and do not open the gate.

### **Turn the Automatic Homing Feature "ON!"**

1. Call the unit to the lowest floor, and open the door and gate.
2. Push the Emergency Stop Knob.
3. Press & hold 2 lowest floor Car Operating Panel buttons (simultaneously) until they illuminate and release.
4. Immediately press the desired home floor call button while the 2 lowest floor Car Operating Panel buttons are illuminated. (They will time out in about 6 seconds). This tells the controller which floor will become the home location.
5. The selected automatic homing floor will flash multiple times to acknowledge the homing program has been accepted. If this does not occur, repeat the previous steps.
6. Reset the Emergency Stop Knob by pulling firmly.
7. Close all gates and doors to start the homing timer.

### **Turn Automatic Homing Feature "Off".**

1. Call unit to the lowest floor, and open the door and gate.
2. Push the Emergency Stop Knob.
3. Press & hold the 2 lowest floor Car Operating Panel buttons until they are illuminated. Keep holding them until they turn "Off".
4. Reset the Emergency Stop Knob by pulling it firmly. The flooring homing program is now turned "Off"
5. Close all gates and doors.

### You Tube Unlinked Instructional Video Links

How to Turn the Automatic Homing ON and OFF

<https://youtu.be/VAgFkdzxrU>

*(The address is case sensitive)*

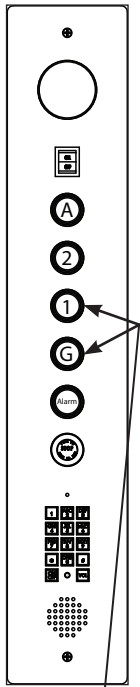

2 lowest floor  
Car  
Operating  
Panel buttons  
may not be  
labeled with a  
1 & 2

## Leveling Program

The hydraulic elevator system will weep hydraulic oil back into the tank when the elevator sits for extended periods. This will cause the elevator car to sink down to a maximum of 1/2 inch below the current floor before the unit will re-level with that floor. Leveling up or down may also occur when the elevator car becomes heavily loaded or unloaded.

**Note :** If your elevator re-levels more than 1 time per hour without being used, call your dealer.

# Description of Elevator Programs Continued...

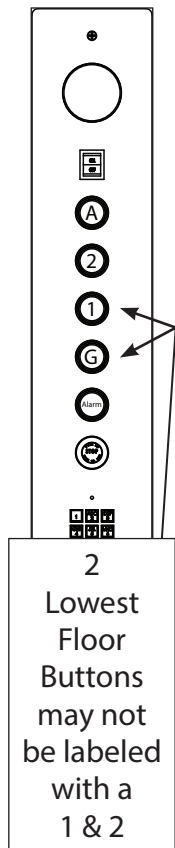

## Exercise Program

The exercise program is a maintenance feature for residents that leave for an extended time or rarely use their elevator. This will help to keep the hydraulic system lubricated and prevent seals from drying out. This is achieved by cycling the elevator between the first two floors every two weeks. Once the timer expires, the unit calls itself to floor 2, waits 120 seconds, and calls itself down to floor one. Then the two-week timer starts over. If a call is placed during the two-week timer, the elevator will function normally, and the timer will restart after the call is complete. **This feature is enabled by default when the elevator ships. To stop this feature, the program must be deactivated.**

### **To Turn "OFF" or "ON"**

1. Call unit to the second stop.
2. Once elevator arrives at the second stop, open gate and push emergency stop knob.
3. Press and hold the 2 lowest floor Car Operating Panel buttons simultaneously until both illuminate and then release.
4. While the 2 lowest floor Car Operating Panel buttons are illuminated (they will time out in about 6 seconds), **Push 2 to enable** or **Push 1 to disable** the exercise program.
5. Reset the Emergency Stop Knob by pulling it firmly.

---

## Elevator Entry Monitoring

The elevator control system monitors the car gate(s) and hoistway door locks.

Every time the hoistway door opens, the elevator car gate must open. If this does not happen, the elevator will no longer accept calls. The elevator car can move between floors up to four times before the hoistway door and the elevator car gate must be opened and closed. If either an elevator car gate or hoistway door, is left open, the elevator will not accept calls until either an elevator car gate or hoistway door is closed.

---

## Safety Run Timer

If the unit can not make it to the called upper floor because of being overloaded or the oil in the tank is low, the pump will only run for 90 seconds before timing out. The elevator car will call itself to the lowest floor, and the car lights will flash. If this occurs, contact your local dealer for service.

# Description of Elevator Programs Continued...

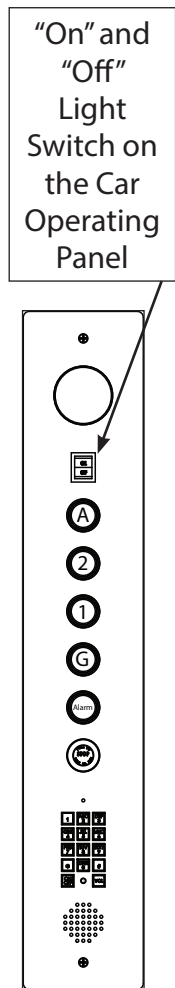

## Electromechanical Interlock Timer EMI (Pot 1)

The interlock timer is an adjustable timer that controls the time period that an Electromechanical Interlock (EMI) will remain unlocked, allowing for the door to open. When the unit arrives at the floor, the interlock will remain unlocked for a time period of 10 to 120 seconds. The user will be required to press the immediate floor call button to open the door after the set time period has expired. This feature pertains to the residential elevator program that is equipped with Electromechanical Interlocks (EMI). Some residential applications are equipped with mechanical interlocks that work independently and ignore the interlock timer. Please contact your local dealer if you require your interlock timer to be adjusted.

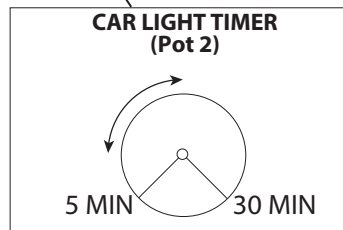
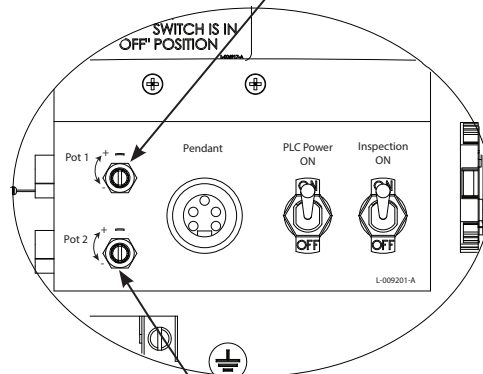
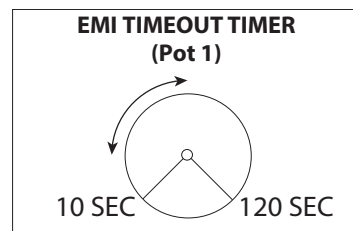

## Car Light Time-Out (Pot 2)

If the car light switch is in the "ON" position and the hoistway door is closed, The car light time-out pot can be set to turn the lights off anywhere from 5-30 mins. The car light timer pot can be adjusted inside the controller. If the hoistway door is left open; the lights will stay "ON" until switched "OFF" on your Car Operating Panel or the hoistway door is closed.

# Description of Elevator Programs Continued...

## “Door Fault” Light and Resetting the Elevator

(Per State Requirement)

The elevator controller will monitor the door closed and door locked circuit of the hoistway door interlocks on all floor landings. If the elevator detects the door closed circuit opens when the elevator is not within the landing zone it will disable the power to the driving machine. When this happens the elevator will not operate in automatic mode.

In the case of a door fault, check that the hoistway is clear above and below the elevator car from any obstructions and hoistway doors are closed on all floor landings before resetting the system. The elevator can be reset with the master key at the key switch which is located on the lower right outside corner of the controller cabinet in the machine room.

### Important Notes:

- If you have a “Door Fault” light on the hallstation’s; it will turn red when the elevator needs to be reset. Once the elevator is reset, the red “Door Fault” light will turn off immediately.
- If you have a Hallstation Position Indicator (PI), an “X” will appear on the display informing you that the elevator will need to be reset. Once the elevator is reset, the “X” will remain on the display until the elevator reaches a floor landing.

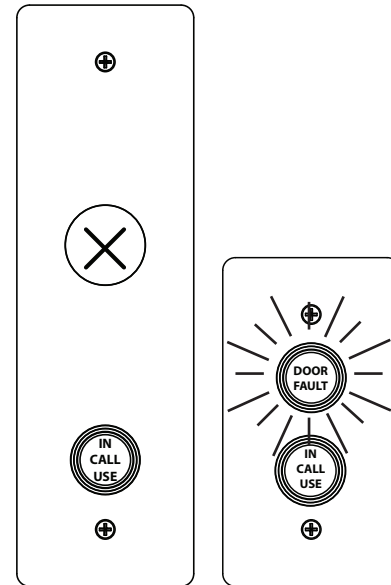

Hallstation Position Indicator (PI) that displays an “X”

Hallstation with red “Door Fault” light

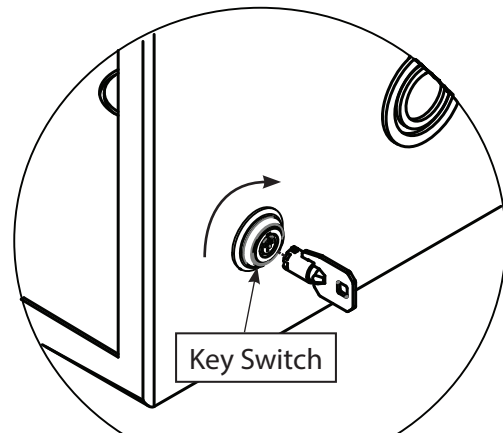

Note: Turn the master key to reset the elevator. Once the elevator is reset, place master key in a safe location.

# IS MY ELEVATOR SAFE?

Are ALL of the following statements about your elevator **TRUE**?

<b>Check Safety Features</b>	<b>True/False</b>
I cannot open any of the hoistway doors unless the elevator is at that floor landing.	T or F
If any other doors, access panels, windows, or other access points to my elevator hoistway are opened then my elevator is automatically disabled.	T or F
My elevator has the required working phone.	T or F
My elevator's alarm bell rings when the alarm button is pressed.	T or F
My elevator emergency stop button disables my elevator?	T or F
My elevator runs only with the gate(s) closed and all the hoistway doors closed.	T or F
If my elevator has a light curtain, my elevator stops when the light curtain is obstructed.	T or F

<b>Check Installation</b>	<b>True/False</b>
My elevator has been installed and serviced by a factory trained technician.	T or F
My elevator hoistway is fully enclosed.	T or F
If my elevator is of the winding drum type, the machine room has a lockable entry door.	T or F
My elevator gate does not allow me to push a three inch diameter ball through it anywhere within the gate up to a height of 67 inches.	T or F
My elevator is used for a single family residence.	T or F
When I stand inside the elevator and open the gate and close the hoistway door, I can measure from the surface of the door to the landing edge and that measurement is 3/4" inches or less.	T or F
I know where my Owner's Manual is located.	T or F
I and members of my family have read my Owner's Manual entirely and completely understand its contents.	T or F

<b>Check Maintenance</b>	<b>True/False</b>
I have hired someone to maintain my elevator to manufacturer's recommended factory specifications.	T or F
My elevator machine room is clutter free, pest free and well lit.	T or F
My elevator machine room is free from any drips or puddles of any type.	T or F
There are no apparent electrical hazards in my elevator machine room.	T or F
The equipment in my elevator machine room is rust free.	T or F
My elevator levels at the floors accurately.	T or F
My elevator responds to calls.	T or F
My elevator car lights work.	T or F
My elevator gate is free from defects or broken pieces.	T or F
My elevator gate is in good working order and condition	T or F
All of the visible elevator mounting hardware is securely fastened. For example, the handrail and interlock.	T or F
My elevator is free of any unusual noises.	T or F
My elevator car is free from any damage.	T or F
My elevator hoistway doors have a working latch set.	T or F

PLEASE REFERENCE THE "YOUR ELEVATOR 101" DIAGRAM IN THE BACK OF THE OWNERS GUIDE.  
IF YOU ANSWERED FALSE OR NEED HELP TO ANSWER THE ABOVE QUESTIONS,  
PLEASE CONTACT YOUR ELEVATOR DEALER.

# Your Elevator 101

**Hall Station**  
**"Calling the Elevator" or Call Button**  
 Pressing the call button in the hallway will "call the elevator" to you.

**C.O.P.**  
 The Car Operating Panel (C.O.P.) is the control panel inside the elevator that houses the floor landing buttons, the light switch, the alarm button, the emergency stop switch

**Elevator Car**  
 The elevator car transports passengers from one floor landing to another.

**Floor Landing**  
 A term used to describe each floor on which the elevator will open.

**Rail**  
 The rail is steel track that guides the elevator when it travels up and down.

**Controller**  
 The controller houses the electrical control circuits of the elevator.

**Service Disconnect**  
 Located near the controller in the machine room. The disconnect is the main power switch to the elevator.

**Hydraulic Power Unit**  
 This drive system utilizes a hydraulic jack and wire rope to raise and lower the passengers car.

**Sling**  
 The Sling is an L-shaped steel support that holds the elevator car and is attached to the rail system.

A 3" ball in diameter can NOT fit through anywhere within the gate.

**Electromechanical Interlock**  
 Often referred to as an EMI, is an electromechanical safety lock that prevents the hoistway door (hall door) from opening if the elevator is not at that floor landing.

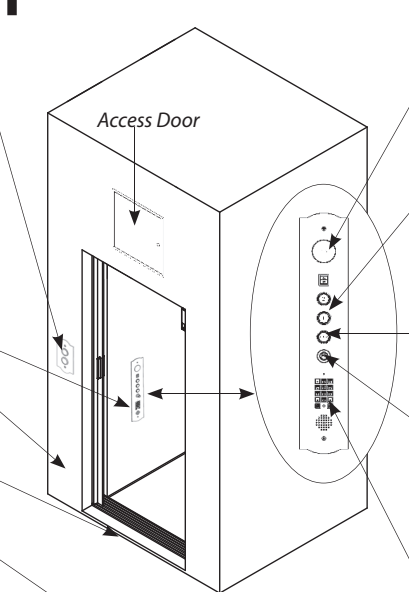

**Emergency Light**  
 The emergency light illuminates if the power goes out.

**Floor Landing Buttons**  
 By pressing the floor landing buttons on the C.O.P. inside the elevator car; The elevator car will take you to the desired floor landing.

**Alarm Button**  
 When you push the alarm button on the C.O.P. inside the elevator car the alarm bell rings alerting others within the home to your need for assistance.

**Emergency Stop**  
 When disabled it prevents the user from moving an elevator or initiating movement of the elevator.

**Telephone**  
 The phone is to place a call during an emergency.

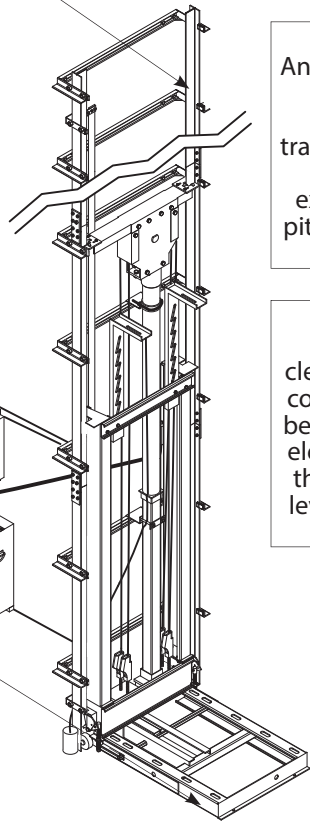

**Hoistway**  
 An opening through a building or structure for the travel of elevators and dumbwaiters extending from the pit floor to the roof or floor above.

**Pit**  
 The pit provides clearance for support components that are below the floor of the elevator car allowing the elevator floor to level with the lowest landing.

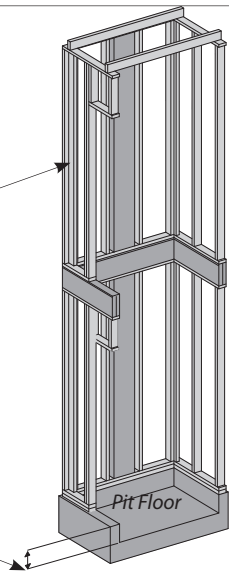

**Gate**  
 The gate secures the opening of the car while the elevator is in operation.

**Note:**  
 Distance between the face of the hoistway door and the edge of the landing sill not to exceed 3/4".

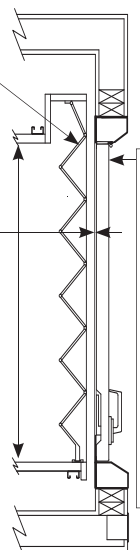

**Hoistway Door**  
 Often referred to as hall door, the hoistway door allows access to the hoistway and is prevented from opening unless the elevator stopped at that particular floor landing.

**Private Residence**  
 A separate dwelling or separate apartment in a multiple dwelling that is occupied only by the members of a single family unit.





## MANUFACTURER'S LIMITED PRODUCT WARRANTY

Fox Valley Elevator LLC. ("Fox Valley Elevator") warrants each new elevator and dumbwaiter to be free from manufacturing defects in material and workmanship under normal use and service for 10 years on structural components: rail and brackets, pedestal base, pedestal, jack bracket, jack cup, sling except movable components, buffer springs, bases and stands. 3 years on mechanical components: sheaves, ram heads, powerheads, car with exceptions for unfinished cars, gate operator except for electrical components, car gates, flexible hoses, access doors, safeties, handrails. 1 year on electrical components: Printed circuit boards, switches, push buttons, motors, drives, power supplies, travel cable, lights and light controllers, PLC'S and other electrical components commencing on the date of shipment from Fox Valley Elevator's factory. Fox Valley Elevator warrants each elevator modification package to be free from manufacturing defects in material and workmanship under normal use and service for a period eighteen (18) months commencing on the date of shipment from Fox Valley Elevator's factory. Fox Valley Elevator warrants each replacement part to be free from manufacturing defects in material and workmanship under normal use and service for ninety (90) days commencing on the date of shipment from Fox Valley Elevator's factory. THIS LIMITED WARRANTY APPLIES ONLY TO THE ORIGINAL END USER AT THE ORIGINAL INSTALLATION LOCATION AND IS NOT TRANSFERABLE.

### Conditions:

1. This Warranty only applies to new elevators, new dumbwaiters, and new elevator modification packages installed by an authorized Fox Valley Elevator Dealer in conforming with current code compliance.
2. This Limited Warranty is void if periodic maintenance of the elevator, dumbwaiter or new elevator modification packages is not being performed by a trained Elevator Technician, Mechanic, or Elevator Personnel in accordance with the recommendations contained in the Owner's Guide. It is the owner's and/or Elevator Technician, Mechanic, or Elevator Personnel's responsibility to keep records of all such service on site. To maintain warranty, elevators, dumbwaiters, and elevator modifications installed in harsh environments (for example, saltwater exposure, aerosolized chemicals, temperature extremes, etc.), will require additional periodic maintenance.

### Additional Disclaimers:

The sole remedy and Fox Valley Elevator's entire liability under this Limited Warranty is limited to the supply of repair or replacement parts for any defective product or component within the term of this Limited Warranty, as Fox Valley Elevator determines appropriate. Replacement items are warranted under this Limited Warranty for the remaining period of the initial warranty. No oral or written information or advice given by Fox Valley Elevator, its dealers or other distributors, agents or employees shall create any different or additional warranties or in any way increase the scope of this Limited Warranty.

This Limited Warranty does not apply to the following: (1) consumable items 'including but not limited to', light bulbs, batteries, uninterruptible power supplies, oil seals, guide shoes, rollers, drive belts, wire rope, greases, oils. (2) 'including but not limited to', components that are subject to normal wear and





tear, external forces and/or misuse, including metal panels, glass, acrylic, gates, doors, buttons, switches, trim, brake pads, fuses, relay, rectifier. (3) items that require periodic assessment, maintenance and/or replacement. (4) minor mechanical adjustments (such as tightening of nuts, bolts, screws, or realignment of component.)

This Limited Warranty does not cover labor charges for the diagnosis, removal, repair, or replacement of warranty parts. This Limited Warranty does not extend to any nonconformity or defect due to any of the following: failure to comply with recommended maintenance as outlined in the Owner's Guide, installation or service by a non-certified technician or using non-certified parts, misuse, neglect, accident, abuse, modification, user's negligence, improper operation (operation not in accordance with Owner's Guide), fire, flood, electrical surges, acts of God, other external forces, ordinary wear and tear, damage during shipment, improper assembly or installation, or any other reason not due to a manufacturing defect.

FOX VALLEY ELEVATOR SHALL NOT HAVE ANY LIABILITY TO ANY PERSON FOR INCIDENTAL, CONSEQUENTIAL OR SPECIAL DAMAGES OF ANY DESCRIPTION, WHETHER ARISING OUT OF WARRANTY (INCLUDING ANY IMPLIED WARRANTIES) OR ANY OTHER CONTRACT, NEGLIGENCE OR OTHER TORT, OR OTHERWISE. UNDER NO CIRCUMSTANCE SHALL FOX VALLEY ELEVATOR'S LIABILITY EXCEED THE PURCHASE PRICE RECEIVED BY FOX VALLEY FOR THE SPECIFIC ITEM AT ISSUE. Some states do not allow the exclusion or limitation of incidental or consequential damages, so the above limitation and exclusion may not apply to you. This Limited Warranty gives you specific legal rights and you may also have other rights, which vary from state to state.

THIS LIMITED WARRANTY IS THE SOLE AND EXCLUSIVE WARRANTY PROVIDED BY FOX VALLEY ELEVATOR AND IS IN LIEU OF ALL OTHER WARRANTIES, WRITTEN OR ORAL, EXPRESS OR IMPLIED, ARISING BY OPERATION OF LAW OR OTHERWISE. ALL IMPLIED WARRANTIES, INCLUDING IMPLIED WARRANTIES OF MERCHANTABILITY FITNESS FOR A PARTICULAR PURPOSE, NONINFRINGEMENT AND WARRANTIES ARISING FROM COURSE OF DEALING OR USAGE OF TRADE, WHETHER OR NOT THE PURPOSE HAS BEEN DISCLOSED AND WHETHER OR NOT THE ELEVATOR HAS BEEN SPECIFICALLY DESIGNED OR MANUFACTURED FOR BUYER'S USE OR PURPOSE, ARE EXPRESSLY DISCLAIMED AND UNDER NO CIRCUMSTANCE EXTEND BEYOND THE ABOVE STATED LIMITED WARRANTY PERIOD. Some states do not allow limitation on how long an implied warranty lasts, so the above limitation may not apply to you.

#### **Submitting a Limited Warranty Claim**

Warranty claims must be received by Fox Valley Elevator by email or phone and must be assessed and issued by Fox Valley Elevator's Technical Support Specialist within the warranty period.





# FOX VALLEY ELEVATOR™

IS A PROUD MEMBER OF



Fox Valley Elevator, LLC is a proud member of the American Society of Mechanical Engineers (ASME), National Association of Elevator Contractors (NAEC), Canadian Elevator Contractors Association and Association of Members of the Accessibility Industry (AEMA). These symbols assure you of our commitment to high quality and accessibility to everyone.



**800-238-8739**  
foxvalleyelevator.com  
1726 North Ballard Road • Suite 1  
Appleton, WI 54911  
Info@foxvalleyelevator.com



**MADE IN THE USA**



with US and Global Parts